



ERFA•
ALÜMİNYUM

MERDİVEN
PROFİLLERİ

STAIRS
PROFILES



PROFİL KATALOG
PROFILE CATALOGUE



ERFA.

ALÜMİNYUM

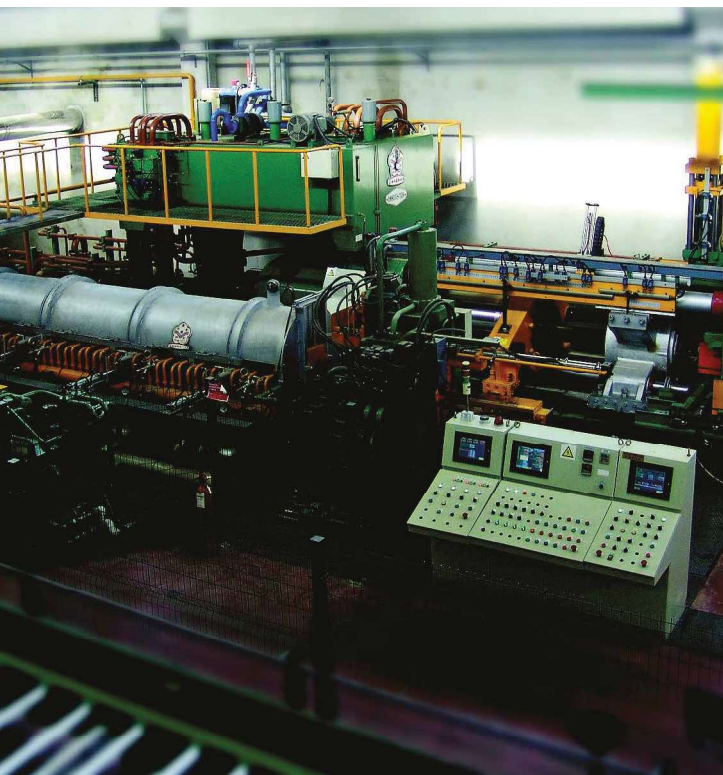



Hakkımızda

1990 yılında İkitelli OSB ' de Alüminyum külçe üretimiyle başlamış olduğumuz iş hayatına, külçe üretimdeki başarılarımızdan dolayı, 2009 yılında almış olduğumuz kararla Velimeşe OSB'de 50.000 m2 açık alan üzerine 9000 m2 kapalı alana yapmış olduğumuz fabrikada Alüminyum Billet üretim tesisi kurarak 3500 ton kapasiteli üretimle, Alüminyumda sürdürdüğümüz başarılar sayesinde 2019 yılında ERFA ALÜMİNYUM olarak Velimeşe OSB 'de satın aldığımız 12.000 m2 kapalı alana sahip fabrikamızda Alüminyum Ekstrüzyon üretimine başladık.

Erfa Alüminyum, kalıp üretimi ile başlayan tüm süreçleri kapsayan, ekstrüzyon üretimi, elektrostatik toz boya, ahşap kaplama, anotlanmış kaplamalar, mekanik proses ile devam eden entgre bir tesistir. CNC işleme merkezleri, modern şubeler ve kalifiye personel ile mevcut üretim desteklenmektedir. Özel müşteri profilleri için kalıp üretimi de modern şubeler ve kalifiye personel ile mevcut üretim desteklenmektedir. Özel müşteri profilleri için kalıp üretimi de modern ekipmanlarla gerçekleştirilmektedir. Her gün 6000' den fazla ürün çeşidi ile sektördeki yerini güçlendirmektedir. Standart RAL renklerine ek olarak müşterilerimize özel renk talepleri de sunmakta olup, 7.000 ton kapasiteli Statik Toz boya da Tesisi bünyesinde bulunmaktadır. Çorlu'da yeni Toz Boyalama ünitemizin Faaliyete geçmesiyle, 8.000 mm uzunluğunda profiller oluşturabilmektedir. 2019 yılında faaliyete geçen İşleme Merkezi ile birlikte, profil yüzey delme, havşa açma delme, boşaltma, CNC işlemleri hassas kesim, açılı kesim, delme , kord vb. işlemler yapılmaktadır.

Alüminyum profil endüstrisinde sürekli olmayı hedefleyen firmamızda kalite sistemi çalışmalarını ile bu hedefe ulaşmada hızla ilerlemektedir. Firmamız, CE, TSI, EN, Gost-R, Statik toz boya uygulamaları için QUALICOAT, eloksal kaplama uygulamaları için QUALANOD, ISO 9001 : 2008, ISO 14001 : 2004, OHSAS 18001 : 2007 ve ISO / IEC belgelerine sahiptir. 27001 - Bilgi Güvenliği Yönetim Sistem sertifikaları Ayrıca ERFA ALÜMİNYUM. ve TRA. INC , REACH ve ROHS kısıtlamalarında (ağır metaller) size sağlanan malzemelerin kimyasallarının yasal sınırlar içinde olduğunu onaylar. Her türlü mühendislik ve mimari uyumluluğumuzla müşterilerimize servis sunmaktayız.

About Us

We started our business life in 1990 with the production of Aluminum ingots in İkitelli OSB, due to our success in ingot production, with the decision we took in 2009, by establishing an Aluminum Billet production facility on a 50.000 m2 open area and 9000 m2 closed area in Velimeşe OSB, with a production capacity of 3500 tons, Thanks to our continued success in aluminum, we started Aluminum Extrusion production in our factory with a closed area of 12.000 m2, which we bought in Velimeşe OSB in 2019 as ERFA ALUMINUM.

Erfa Aluminum is an integrated facility that covers all processes starting with mold production and continues with extrusion production, electrostatic powder paint, wood coating, anodized coatings, mechanical process. Existing production is supported by CNC machining centers, modern branches and qualified personnel. Mold production for special customer profiles is also supported by modern branches and qualified personnel. Mold production for special customer profiles is also carried out with modern equipment. It strengthens its position in the sector with more than 6000 product types every day. In addition to the standard RAL colors, we also offer our customers special color requests, and Static Powder paint with a capacity of 7.000 tons is also available in its facility. With the commissioning of our new Powder Coating unit in Çorlu, profiles with a length of 8.000 mm can be created. With the Machining Center, which became operational in 2019, profile surface drilling, countersinking drilling, unloading, CNC operations, precision cutting, angle cutting, drilling, cord and so on. transactions are made

Our company, which aims to be continuous in the aluminum profile industry, is progressing rapidly in achieving this goal with its quality system studies. Our company has CE, TSI, EN, Gost-R, QUALICOAT for static powder coating applications, QUALANOD for anodized coating applications, ISO 9001 : 2008, ISO 14001 : 2004, OHSAS 18001 : 2007 and ISO / IEC certificates. 27001 - Information Security Management System Certificates Also ERFA ALUMINUM. and TRA. INC certifies that the chemicals of the materials supplied to you in the REACH and ROHS restrictions (heavy metals) are within the legal limits. We provide service to our customers with all kinds of engineering and architectural compatibility.

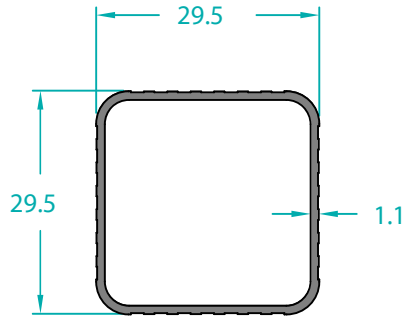

15135 0,312 Kg/m

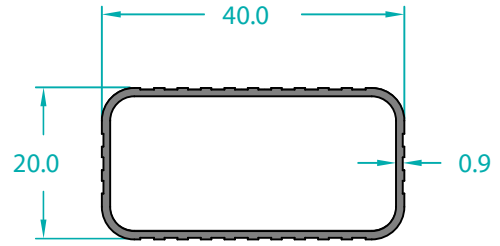

15140 0,304 Kg/m

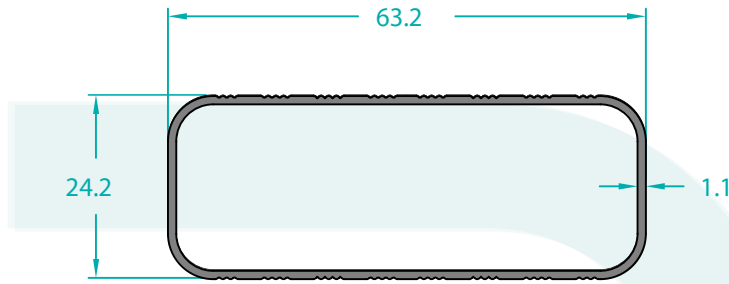

15139 0,466 Kg/m

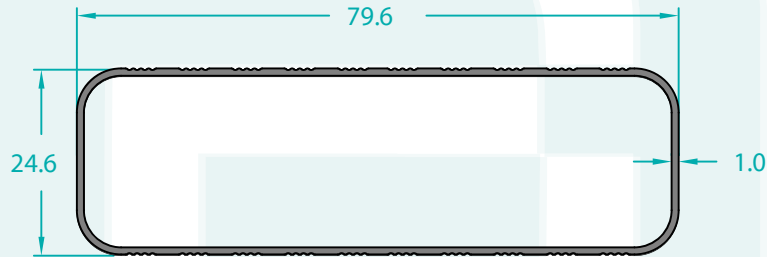

15136 0,482 Kg/m

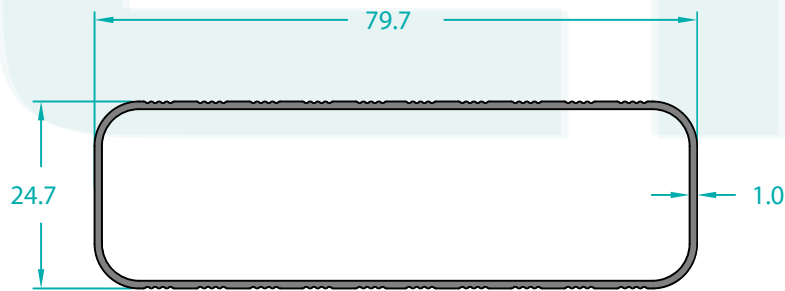

15137 0,509 Kg/m

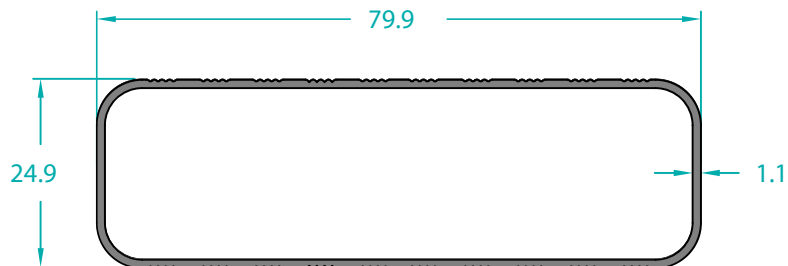

15138 0,564 Kg/m



ERFA.

ALÜMİNYUM



ERFA.
ALÜMİNYUM



Velimeşe OSB. Mahallesi 233. Sokak No:11/1
Çorlu / TEKİRDAĞ / TURKEY



+90 282 674 55 25



info@erfaaluminyum.com



www.erfaaluminyum.com



/erfaaluminyum